

2/2-Wege Magnetventil 2/2-way solenoid valve

Baureihe 245 Type 245

direktgesteuert
direct acting

Schaltfunktion A: NC (stromlos geschlossen)
Function A: NC (normally closed)

Schaltfunktion B: NO (stromlos offen)
Function B: NO (normally open)

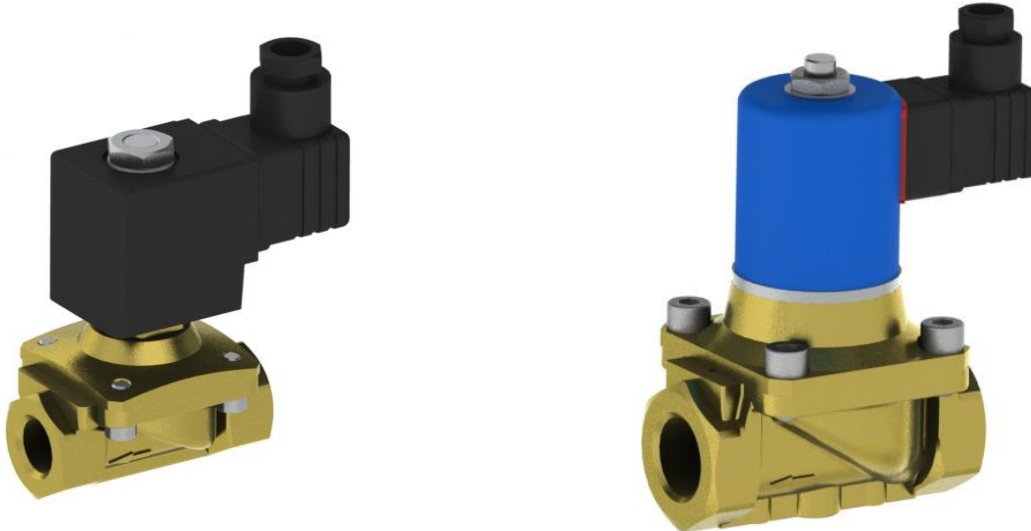
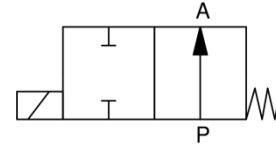
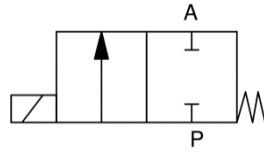

Bauart	Sitzventil	Design	Seat valve
Nennweite	DN 12 – 50	Diameter	DN 12 – 50
Druckbereich	0 – max. 1,0bar (siehe Tabelle)	Pressure range	0 – max. 1,0bar (see table)
Gehäusewerkstoff	Messing, Edelstahl auf Anfrage	Body material	Brass, stainless steel on request
Dichtwerkstoff	NBR, EPDM, FKM	Seal material	NBR, EPDM, FKM
Temperatur	Medium: -10 bis +80°C Umgebung: -10 bis +50°C Abweichende Temperaturbereiche sind möglich, müssen jedoch als Einzelfall geprüft werden.	Temperature	Media: -10 up to +80°C Ambient: -10 up to +50°C Different temperature ranges are possible, but have to be checked as an individual case.
Anschluss	G3/8 – G2	Connection	G3/8 – G2
Elektr. Anschluss	Gerätesteckdose nach DIN EN 175301-803 Bauform A	Electr. connection	Plug acc. DIN EN 175301-803 form A
Anschlussspannung	230V 50Hz, 24V DC, Sonderspannungen	Nominal voltage	230V 50Hz, 24V DC, special voltages
Spannungstoleranz	± 10% nach VDE 0580	Voltage tolerance	± 10% acc. VDE 0580
Leistungsaufnahme	Siehe Tabelle	Power consumption	See table
Einschaltdauer	100% ED	Duty factor	100% ED
Schutzart	IP 65 mit montierter Gerätesteckdose	Protection class	IP 65 with plug mounted
Einbaulage	Magnet vorzugsweise oben	Mounting	Solenoid preferably in upright position

2/2-Wege Magnetventil
2/2-way solenoid valve
Baureihe 245
Type 245

DN	Druck Pressure range [bar]	Anschluss Connection	Kv-Wert Flow rate [m ³ /h]	Gewicht Weight [kg]	Leistungsaufnahme Power consumption [W]
12	0 – 1,0	G3/8	2,0	0,7	20
12	0 – 1,0	G1/2	2,1	0,7	20
20	0 – 0,3	G3/4	8,0	1,7	25
25	0 – 0,3	G1	9,0	1,6	25
32	0 – 0,2	G1 1/4	14,0	5,0	60
40	0 – 0,2	G1 1/2	20,0	4,8	60
50	0 – 0,1	G2	28,0	6,2	60

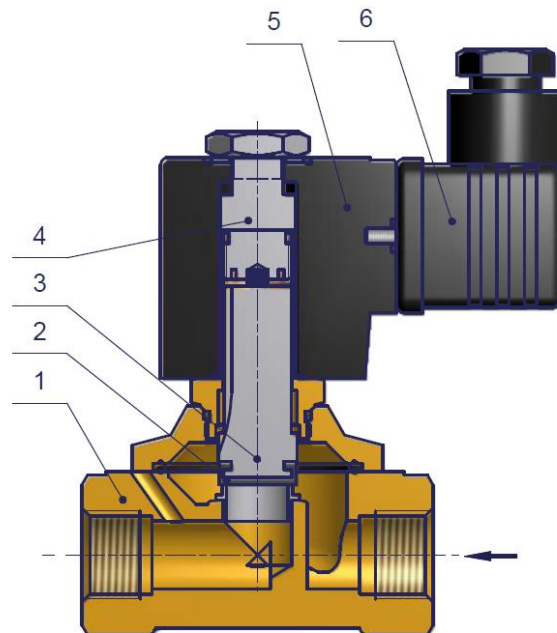
Schnittzeichnung
Sectional drawing

Pos. Pos.	Menge Quantity	Benennung	Description
1	1	Ventilkörper	Valve body
2	1	Dichtkappe	Sealing cap
3	1	Anker	Plunger
4	1	Magnetschlusshülse	Solenoid tube
5	1	Magnet	Solenoid
6	1	Gerätesteckdose	Plug

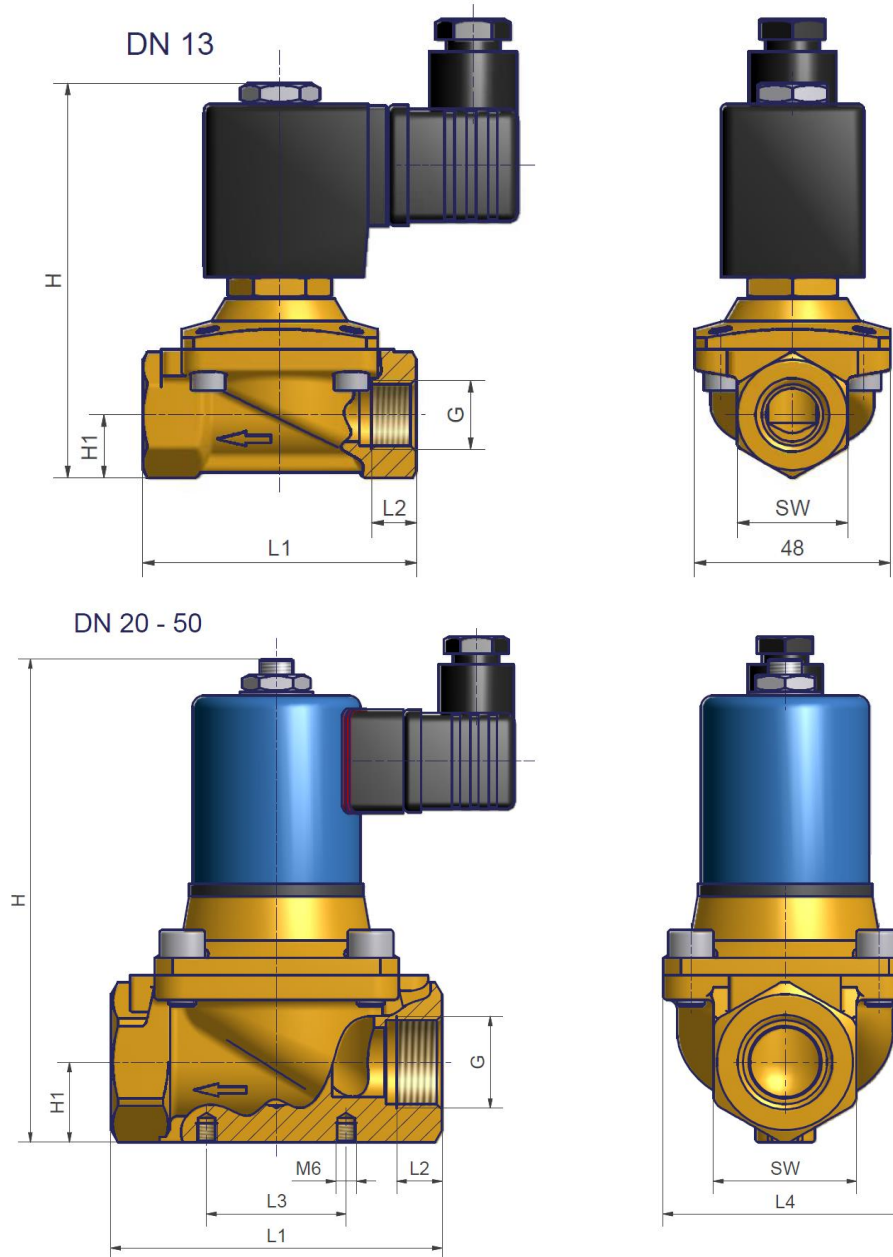
2/2-Wege Magnetventil
2/2-way solenoid valve
Baureihe 245
Type 245
Maßzeichnung
Dimension drawing

DN	G	SW [mm]	H [mm]	H1 [mm]	L1 [mm]	L2 [mm]	L3 [mm]	L4 [mm]
12	3/8	27	97	15	67	11	-	48
12	1/2	27	97	15	67	11	-	48
20	3/4	41	139	23	95	13	40	70
25	1	41	139	23	95	13	40	70
32	1 1/4	60	213	33	132	20	55	96
40	1 1/2	60	213	33	132	20	55	96
50	2	70	225	39	160	24	-	112

2/2-Wege Magnetventil 2/2-way solenoid valve



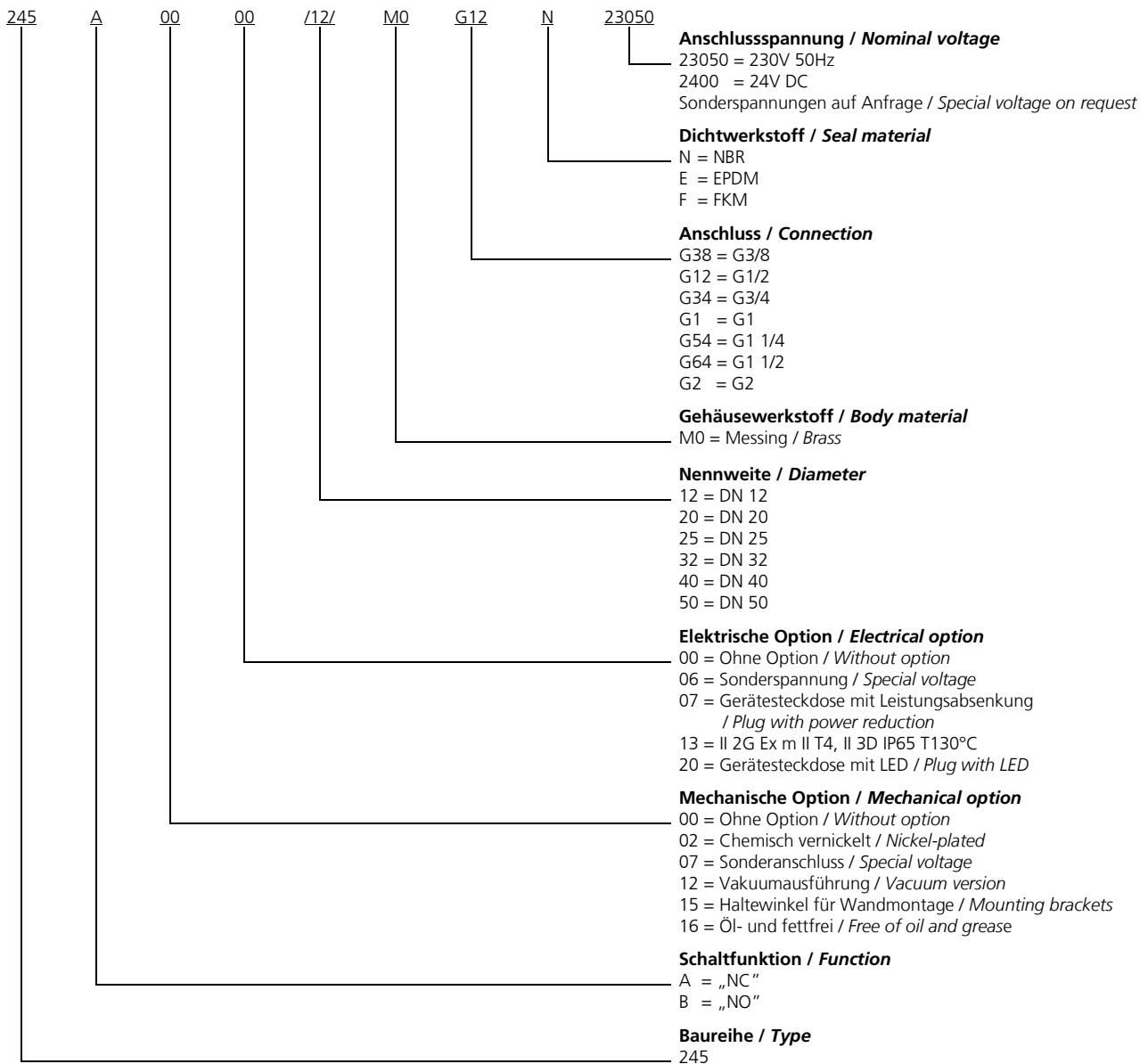

Baureihe 245 Type 245

Typenschlüssel Type code

Die Typenbezeichnung setzt sich zusammen aus:
Structure of the order specification:

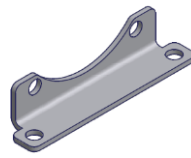

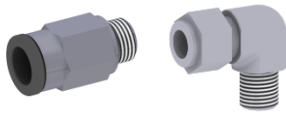
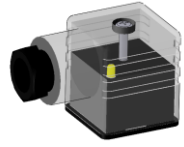
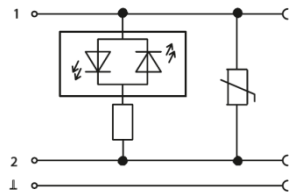
2/2-Wege Magnetventil
2/2-way solenoid valve
Baureihe 245
Type 245
Zubehör
Accessories

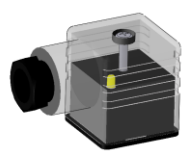
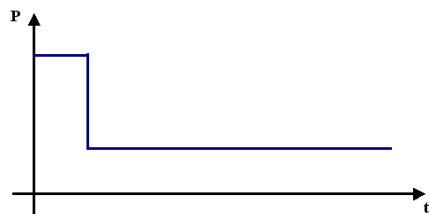
	Haltewinkel <i>Mounting brackets</i> mechanische Option = 15 <i>mechanical option = 15</i>	
	Edelstahl 1.4503 <i>Stainless steel AISI 303</i>	
	Verschraubungen <i>Fittings</i>	siehe Datenblatt Verschraubungen <i>see datasheet fittings</i>
	Gerätesteckdose mit LED <i>Plug with LED</i> elektrische Option = 20 <i>electrical option = 20</i>	
	Sonderschutzart <i>Explosion proof</i> II 2G Ex m II T4 II 3D IP65 T130°C elektrische Option = 13 <i>electrical option = 13</i>	Der Betriebsdruck ist bei Ex-Ausführung um ca. 20% reduziert <i>The operating pressure is reduced by 20% in Ex specification</i>
	Gerätesteckdose mit angespritztem Kabel <i>Plug with cable</i>	
	Gerätesteckdose mit Leistungsabsenkung 24V DC, Bauform A <i>plug with power reduction 24V DC, form A</i> elektrische Option = 07 <i>electrical option = 07</i>	

Weitere Optionen und Zubehör stimmen wir gerne auf Ihre Anforderungen ab.
We gladly coordinate further options and accessories according to your requirements.